



GENERAL INFORMATION - 2016

Population
18.4 Millions

GDP
22 163 Millions current US\$

Merchandise trade
6 300 Millions current US\$

Internet users
5.9 Millions

GDP growth
-3.4 %

Land area
183 630 km²

Source: UNCTAD and ITU (complete URL addresses in the General Notes)

E-COMMERCE ASSESSMENT - 2017

Rank in UNCTAD B2C E-commerce Index
127/144

Rank in ITU ICT Development Index
126/176

Rank in WEF Networked Readiness Index
-/139

Source: UNCTAD, ITU and WEF (complete URL address in the General Notes)

Note: 1 = Best

ICT INFRASTRUCTURE AND SERVICES - 2016

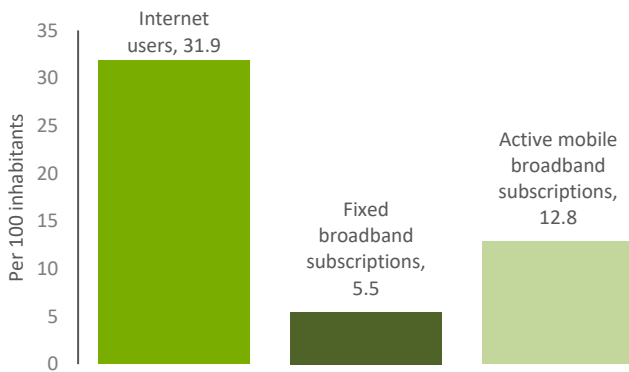

Source: ITU (complete URL address in the General Notes)

Fixed broadband Internet tariffs, PPP \$/month

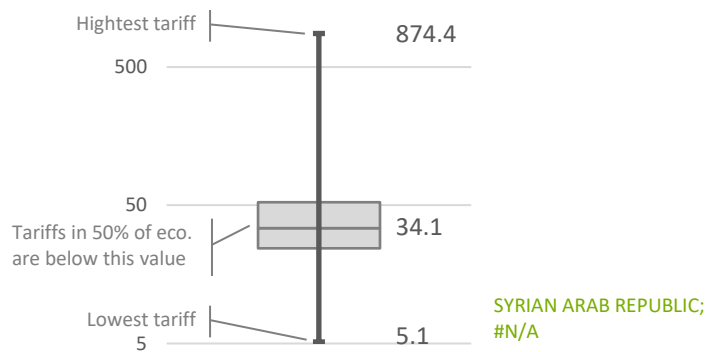

PAYMENTS - 2014

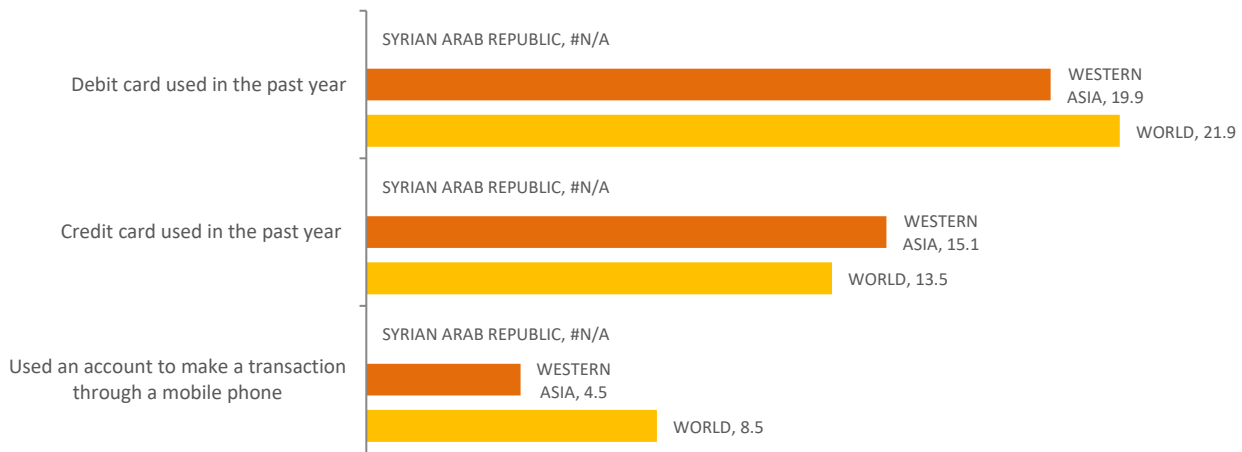

Source: World Bank (complete URL address in the General Notes)

COUNTRY PROFILE: SYRIAN ARAB REPUBLIC

TRADE LOGISTICS - 2016

Percent of population having mail delivered at home

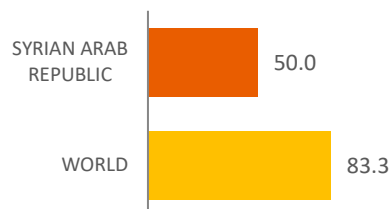

Postal reliability index (0 to 100, 100 = Best)

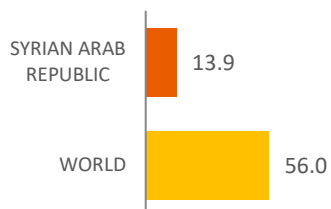

Days to clear direct exports through customs

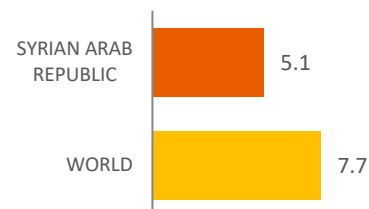

Source: UPU and World Bank (complete URL addresses in the General Notes)

LEGAL AND REGULATORY FRAMEWORKS - 2017



SYRIAN ARAB REPUBLIC

Electronic Transactions:	Legislation
Consumer Protection:	Legislation
Privacy and data protection:	No legislation
Cybercrime:	Legislation

Source: UNCTAD

For more information see: http://unctad.org/en/Pages/DTL/STI_and_ICTs/ICT4D-Legislation/eCom-Global-Legislation.aspx

SKILLS DEVELOPMENT - 2013-17

Percentage of firms using e-mail to interact with clients/suppliers

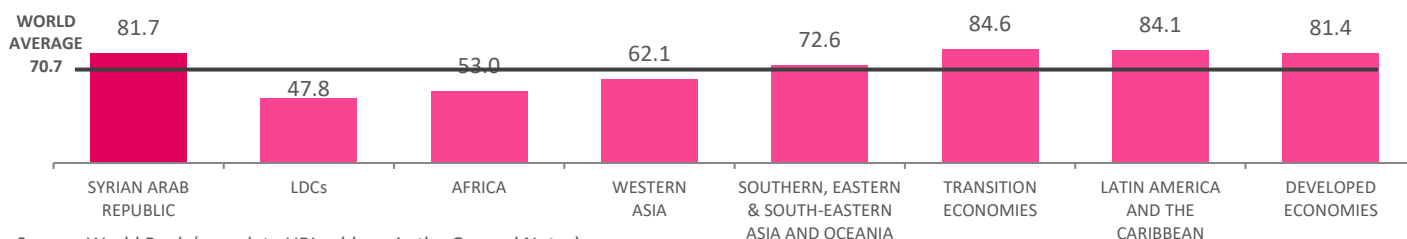

Source: World Bank (complete URL address in the General Notes)

FINANCING FOR eCOMMERCE - 2014-15

Percentage of firms identifying access to finance as a major constraint

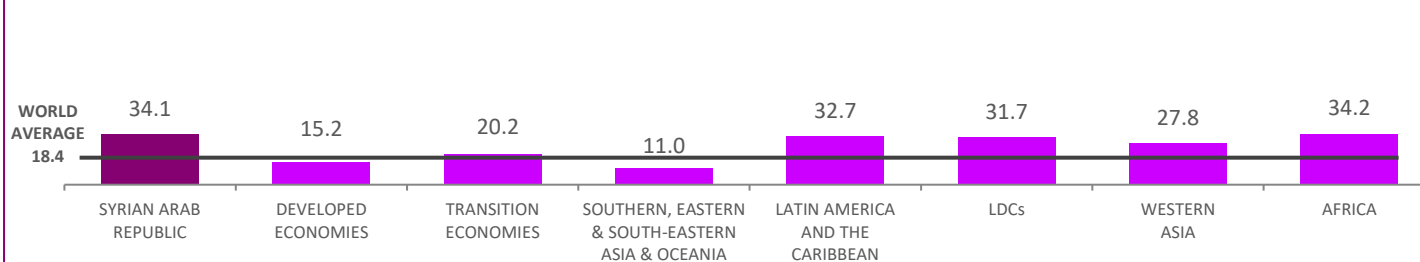

Source: World Bank (complete URL address in the General Notes)

COUNTRY PROFILE: GENERAL NOTES

NOTES:

- For merchandise trade - sum of exports and imports.
- Country groups are weighted using population for most indicators with the exception of those on skills development, financing for e-commerce and days to clear direct exports through customs.

SYMBOLS FOR MISSING VALUES:

0: Zero means nil or negligible

#N/A: Not available or not publishable

FOR MORE INFORMATION ON DATA SOURCES SEE:

- ITU, World Telecommunication/ICT Indicators database: <http://www.itu.int/en/ITU-D/Statistics/Pages/publications/wtid.aspx>
- UNCTAD, UNCTADStat: <http://unctadstat.unctad.org>
- UPU, Postal Statistics: <http://www.upu.int/en/resources/postal-statistics/about-postal-statistics.html>
- World Bank, E-trade Indicators: <http://wits.worldbank.org/analyticaldata/etrade-indicators.aspx>
- WEF, Networked Readiness Index: <http://reports.weforum.org/global-information-technology-report-2016/networked-readiness-index>

DISCLAIMER:

- The designations employed do not imply the expression of any opinion concerning the legal status of any country, territory, city or area, or of its authorities, or concerning the delimitation of its frontiers or boundaries.

GENERATION DATE:

3 July 2018